

**Cyclone Dust Collector**  
Operating Instructions



**Producer:**

Laguna Tools Inc  
744 Refuge Way, Suite 200  
Grand Prairie, Texas 75050  
USA  
Phone: +1 800-234-1976  
Website: [www.lagunatools.com](http://www.lagunatools.com)

**Distributor:**

IGM nástroje a stroje s.r.o.  
Ke Kopanině 560, 252 67, Tuchoměřice  
Czech Republic, EU  
Phone: +420 220 950 910  
E-mail: [sales@igmtools.com](mailto:sales@igmtools.com)  
Website: [www.igmtools.com](http://www.igmtools.com)





## EC DECLARATION OF CONFORMITY

According to the following EC Directives  
- Machinery Directive : 2006/42/EC



The undersigned, Stephen Stoppenbrink, representing Laguna Tools Inc.  
744 Refuge Way, Suite 200, Grand Prairie, Texas 75050 USA, manufacturer, declares that  
the machine described hereafter :

### **DUST COLLECTOR**

#### **MODEL:**

AFLUX12 (230V/50Hz)  
BFLUX1 (230V/50Hz)  
CFLUX3 (415V/50Hz)  
PFLUX3 (415V/50Hz)  
CFLUX1 (230V/50HZ)  
PFLUX1 (230V/50HZ)

Provided that it is used and maintained in accordance with the generally accepted codes of good practice and the recommendations of the instructions manual, meets the essential safety and health requirements of the Machinery Directive.

The person who compile technical file established within the EU:

Name: IGM nastroje a stroje s.r.o.

Address: Ke Kopanine 560, Tuchomerice , CZ-252 67

Tel.: +420 220 950 910

Email: [sales@igmttools.com](mailto:sales@igmttools.com)

The TCF (No. SF-2018001-A1 / SF-2018002-A1) is archived in CEPROM S.A. located in Str. Fântânele, nr.FN (Platforma Industrială), 440240 Satu Mare, Romania

For the most specific risks of this machine, safety and compliance with the essential requirements of the Directive has been based on elements of:

- EN ISO 12100:2010 / Safety of machinery — General principles for design — Risk assessment and risk reduction (ISO 12100:2010)
- EN 60204-1: 2006+A1:2009+AC:2010 / Safety of machinery - Electrical equipment of machines- Part 1: General requirements- Industrial electrical device.

Date: August 04, 2022

Authorized Signature: 

Position: Chief Executive Officer

Place: Laguna Tools Inc.  
744 Refuge Way, Suite 200, Grand Prairie, Texas 75050,  
USA

# EN - English

## Operating Instructions (translation of the original instructions)

Dear Woodworker,

Thank you for your purchase and welcome to the Laguna Tools group of discerning woodworkers. We understand that you have a choice of where to purchase your machines and appreciate the confidence you have in the Laguna Tools brand. Every machine manufactured by Laguna Tools has been carefully designed and well thought through from a woodworker's perspective. Through hands-on experience, Laguna Tools is constantly working hard to make innovative, precision products. Products that inspire you to create works of art, are a joy to run and work on, and encourage your performance.

## Contents

### 1. Declaration of conformity

#### 1.1 Warranty

### 2. PFlux1 Specifications

### 3. General Safety Rules and Instructions

#### 3.1 Important Safety Instructions

#### 3.2 General Rules

#### 3.3 Additional Safety Instructions

#### 3.4 Power Supply

#### 3.5 Motor Specifications

#### 3.6 Grounding Instructions

### 4. Parts Description

#### 4.1 Functions

### 5. Assembly

#### 6.1 Unpacking

#### 6.2 Assembling the Unit

### 6. Maintenance

### 7. Troubleshooting

### 8. Power connection and wiring diagram

### 9. Parts breakdown / Exploded Views

### 10. Parts list

#### 1. Declaration of conformity

We declare that this product is in compliance with the directive and the standard mentioned on the previous page of this manual.

#### 1.1 Warranty

IGM Tools & Machinery strives to always deliver high-quality machinery. The warranty is governed by the valid terms and conditions of IGM Tools & Machinery available at [www.igmtools.com](http://www.igmtools.com).

#### 2. Specifications

Motor	1100 W (1.5hp)
Power	230V / 50Hz / 1PH
Recommended Breaker	20 Amps (Type D)
Airflow (traditional method)	1786m <sup>3</sup> /hour (1051CFM)
Airflow (realistic method)	1224m <sup>3</sup> /hour (720CFM)
Max. Static Pressure	256mm in water
Fan Diameter	340mm
Inlet Diameter	1x 150mm or 2 x 100mm
Switch	High frequency remote control switch
Noise	70 dB(A) @ 3m
Drum Collection	95 Litre octagonal drum
Packing Size (LxWxH)	1150 x 720 x 1195mm
Weight	122 kg
Shipping Weight	145 kg
Filter	
Filtering Area:	4.5m <sup>2</sup>
Cartridge Filter	400mm diameter x 500mm height
Filtration Size	HEPA - 99.2 %, 0.4 Micron
Drum Collection Bag Layflat Size	960 x 1200 mm

### 3. General Safety Rules and Instructions

#### 3.1 Important Safety Instructions

Read and understand all warnings and operating instructions before using this equipment. Failure to follow all instructions listed below, may result in electric shock, fire, and/or serious personal injury or property damage.

Woodworking can be dangerous if safe and proper operating procedures are not followed. As with all machinery, there are certain hazards involved with the operation of the product. Using the machine with respect and caution will considerably lessen the possibility of personal injury. However, if normal safety precautions are overlooked or ignored, personal injury to the operator may result. Safety equipment such as guards, push sticks, hold-downs, feather boards, goggles, dust masks and hearing protection can reduce your potential for injury. But even the best guard won't make up for poor judgment, carelessness or inattention. Always use common sense and exercise caution in the workshop. If a procedure feels dangerous, don't try it. Figure out an alternative procedure that feels safer. REMEMBER: Your personal safety is your responsibility.

This machine was designed for certain applications only. We strongly recommend that this machine not be modified and/or used for any application other than that for which it was designed. If you have any questions relative to a particular application, do not use the machine until you have first contacted the manufacturer to determine if it can or should be performed on the product.

If you have any questions relative to its application do not use the product until you have contacted the manufacturer and we have advised you.

When using an electrical appliance, basic precautions should always be followed, including the following:

#### READ ALL INSTRUCTIONS BEFORE USING (THIS APPLIANCE)

To reduce the risk of fire, electric shock, or injury:

- Do not leave appliance when plugged in. Unplug from outlet when not in use and before servicing.
- Do not use outdoors or on wet surfaces.
- Do not allow to be used as a toy. Close attention is necessary when used by or near children.
- Use only as described in this manual. Use only manufacturer's recommended attachments.
- Do not use with damaged cord or plug. If appliance is not working as it should, has been dropped, damaged, left outdoors, or dropped into water, return it to a service centre.
- Do not pull or carry by cord, use cord as a handle, close a door on cord, or pull cord around sharp edges or corners. Do not run appliance over cord. Keep cord away from heated surfaces.
- Do not unplug by pulling on cord. To unplug, grasp the plug, not the cord.
- Do not handle plug or appliance with wet hands.
- Do not put any object into openings. Do not use with any opening blocked; keep free of dust, lint, hair, and anything that may reduce air flow.
- Keep hair, loose clothing, fingers, and all parts of body away from openings and moving parts.
- Turn off all controls before unplugging.
- Use extra care when cleaning on stairs.

- Do not use to pick up flammable or combustible liquids, such as gasoline, or use in areas where they may be present.
- Connect to a properly grounded outlet only. See Grounding Instructions

#### SAVE THESE INSTRUCTIONS

- Read and understand the warnings posted on the machine and in this manual. Failure to comply with all of these warnings may cause serious injury.
- Replace the warning labels if they become obscured or removed.
- This 3HP Portable Cyclone Dust Collector is designed and intended for use by properly trained and experienced personnel only. If you are not familiar with the proper and safe operation of this type of dust collector, do not use until proper training and knowledge have been obtained.
- Do not use this machine for other than its intended use. If used for other purposes, LAGUNA TOOLS INC., disclaims any real or implied warranty and holds itself harmless from any injury that may result from that use.
- Always wear approved safety glasses/face shields while using this machine.
- Before operating this dust collector, remove tie, rings, watches and other jewelry, and roll sleeves up past the elbows. Remove all loose clothing and confine long hair. Non-slip footwear or anti-skid floor strips are recommended. Do not wear gloves.
- Wear ear protectors (plugs or muffs) during extended periods of operation.
- Some dust created by power sanding, sawing, grinding, drilling and other construction activities contain chemicals known to cause cancer, birth defects or other reproductive harm. Some examples of these chemicals are:
  - Lead from lead based paint.
  - Crystalline silica from bricks, cement and masonry products.
  - Arsenic and chromium from chemically treated lumber.

Your risk of exposure varies, depending on how often you do this type of work. To reduce your exposure to these chemicals, work in a well-ventilated area and work with approved safety equipment, such as face or dust masks that are specifically designed to filter out microscopic particles.

- Do not operate this machine while tired or under the influence of drugs, alcohol or any medication.
- Make certain the switch is in the OFF position before connecting the machine to the power source.
- Make certain the machine is properly grounded.
- Make all machine adjustments or maintenance with the machine unplugged from the power source.
- Form a habit of checking to see that all extra equipment such as adjusting keys, wrenches, scrap, stock, and cleaning rags are removed away from the machine before turning on.
- Keep safety guards in place at all times when the machine is in use. If removed for maintenance purposes, use extreme caution and replace the guards immediately when maintenance is complete.
- Make sure the dust collector is on a flat even surface and the wheels locked in place before use.
- Check damaged parts. Before further use of the machine, a guard or other part that is damaged should be carefully checked to determine that it will operate properly and perform its intended function. Check for alignment of moving parts, binding of moving parts, breakage of parts, mounting and any other conditions that may affect its operation. A guard or other part that is damaged should be properly repaired or replaced.
- Provide for adequate space surrounding work area and non-glare, overhead lighting.
- Keep the floor around the machine clean and free of scrap material, oil and grease.
- Keep visitors a safe distance from the work area. Keep children away.
- Make your workshop child proof with padlocks, master switches or by removing starter keys.

- Give your work undivided attention. Looking around, carrying on a conversation and “horse-play” are careless acts that can result in serious injury.
- Maintain a balanced stance at all times so that you do not fall or lean against the dust collector. Do not overreach or use excessive force to perform any machine operation.
- Use the right tool at the correct speed and feed rate. Do not force a tool or attachment to do a job for which it was not designed. The right tool will do the job better and safer.
- Use recommended accessories; improper accessories may be hazardous.
- Maintain machinery with care. Follow instructions for lubricating and changing accessories.
- Turn off the machine before cleaning. Use a brush or compressed air to remove dust or debris — do not use your hands.
- Do not stand on the machine. Serious injury could occur if the machine tips over.
- Never leave the machine running unattended. Turn the power off and do not leave the machine until it comes to a complete stop.

### 3.2 General safety rules

**WARNING: FAILURE TO FOLLOW THESE RULES MAY RESULT IN SERIOUS PERSONAL INJURY.**

**CHECK DAMAGED PARTS.** Before further use of the unit, properly repair or replace any part that is damaged.

**FOR YOUR OWN SAFETY, READ AND UNDERSTAND THE INSTRUCTION MANUAL BEFORE OPERATING THE MACHINE.** Learn the unit’s application and limitations as well as the specific hazards peculiar to it.

**KEEP WORK AREA CLEAN.** Cluttered areas and benches invite accidents.

**DON’T USE IN DANGEROUS ENVIRONMENT.** Don’t use this unit in damp or wet locations, or expose it to rain. Keep work area well-lighted.

**KEEP CHILDREN AND VISITORS AWAY.** All children and visitors should be kept a safe distance from work area.

**DISCONNECT UNIT** before servicing.

**CHECK DAMAGED PARTS.** Before further use of the unit, properly repair or replace any part that is damaged.

**FAILURE TO FOLLOW THESE RULES MAY RESULT IN SERIOUS INJURY.**

### 3.3 Additional Safety Instructions

#### Additional safety for dust collectors

**Intended use.** This dust collector is only intended for collecting wood dust and chips from woodworking machines. Do not use this dust collector to collect metal, dirt, pebbles, drywall, asbestos, lead paint, silica, liquids, aerosols, or any flammable, combustible, or hazardous materials.

**Hazardous dust.** Dust created while using machinery may cause cancer, birth defects, or long-term respiratory damage. Be aware of dust hazards associated with each work piece material, and always wear a NIOSH-approved respirator to reduce your risk.

**Dust allergies.** Dust from certain woods may cause an allergic reaction in people and animals. Make sure you know what type of wood dust you will be exposed to in case there is a possibility of an allergic reaction.

**Wear respirator.** Fine dust that is too small to be caught in the filter will be blown into the ambient air during operation. Always wear a NIOSH-approved respirator during operation and for a short time after to reduce your risk of permanent respiratory damage.

**Emptying dust.** When emptying dust from the collection container, wear a respirator and safety glasses. Empty dust away from ignition sources and into an approved container.



**Disconnecting power supply.** Turn the switch off, disconnect the dust collector from the power supply, and allow the impeller to come to a complete stop before leaving the machine unattended or doing any service, cleaning, maintenance, or adjustments.

**Suspended dust particles and ignition sources.** Do not operate the dust collector in areas where explosion risks are high. Areas of high risk include, but are not limited to, areas near pilot lights, open flames, or other ignition sources.

**Fire suppression.** Only operate the dust collector in locations that contain a fire suppression system or have a fire extinguisher nearby.

**Impeller hazards.** Do not place your hands or tools near the open inlet during operation for any reason. The powerful suction could easily cause accidental contact with the impeller, which will cause serious personal injury or damage to the machine. Always keep small animals and children away from open dust collection inlets.

**Avoiding sparks.** Do not allow steel or rocks to strike the impeller—this may produce sparks. Sparks can smolder in wood dust for a long time before a fire is detected. If you accidentally cut into wood containing tramp metal (nails, staples, spikes, etc.), immediately turn off the dust collector, disconnect it from power, and wait for the impeller to stop—then empty the collection container into an approved airtight metal container.

**Operating location.** To reduce respiratory exposure to fine dust, locate permanently installed dust collectors away from the working area, or in another room that is equipped with a smoke detector. Do not operate the dust collector in rainy or wet locations—exposure to water may create a shock hazard or decrease the life of the machine.

**Static electricity.** Plastic dust lines generate high amounts of static electricity as dust chips pass through them. Although rare, sparks caused by static electricity can cause explosions or fire. To reduce this risk, make sure all dust lines are thoroughly grounded by using a grounding wire.

**Regular cleaning.** Regularly check/empty the collection bags or drum to avoid the buildup of fine dust that can increase the risk of fire. Make sure to regularly clean the surrounding area where the machine is operated—excessive dust buildup on overhead lights, heaters, electrical panels, or other heat sources will increase the risk of fire.

Warning: If precautions are not heeded, it may result in minor injury and/or possible machine damage.

Warning: If precautions are not heeded, it may result in serious injury or possibly even death.

### SAVE THESE INSTRUCTIONS.

Refer to them often and use them to instruct others.

### 3.4 Motor Specifications

Your machine is wired for 230 volts, 50 HZ alternating current. Before connecting the machine to the power source, make sure the switch is in the "OFF" position.

### 3.5 Grounding Instructions

**DANGER: THIS MACHINE MUST BE GROUNDED WHILE IN USE TO PROTECT THE OPERATOR FROM ELECTRIC SHOCK.**

1. This appliance must be connected to a grounded metal, permanent wiring system; or an equipment-grounding conductor must be run with the circuit conductors and connected to the equipment-grounding terminal or lead on the appliance.

The installer, such as a qualified electrician, cut (or bend over) and insulate the grounding conductor from a field wiring supply cable.

In the event of certain types of malfunctions or breakdowns, grounding provides a path of least resistance for electric current—in order to reduce the risk of electric shock.

Improper connection of the equipment-grounding wire can result in a risk of electric shock. The wire with green insulation (with or without yellow stripes) is the equipment-grounding wire. If repair or replacement of the power cord or plug is necessary, do not connect the equipment-grounding wire to a live (current carrying) terminal. Check with a qualified electrician or service personnel if you do not understand these grounding requirements, or if you are in doubt about whether the tool is properly grounded. If you ever notice that a cord or plug is damaged or worn,

disconnect it from power, and immediately replace it with a new one.

### Electrical Circuit Requirements

You should use a separate electrical circuit for the Laguna PFlux. The circuit should be protected by a 20A circuit breaker with a tripping characteristic C. The power cable of the machine is factory fitted with 230V industrial plug. The machine must be connected to an appropriate industrial socket or the machine can be connected to a terminal board and the wiring corresponding to the recommended fuse.

**ATTENTION! WIRING MAY BE CARRIED OUT BY A QUALIFIED ELECTRICIAN ONLY.**

Recommended circuit breaker: 20A, tripping characteristic C.

**WARNING: MAKE SURE THE SOCKET IS EARTHED. IF YOU ARE NOT SURE, HAVE THE SOCKET CHECKED BY A QUALIFIED ELECTRICIAN.**

## 4. Parts Description

### 4.1 Functional Description

#### High Frequency Remote Control Receiver and Manual Switch

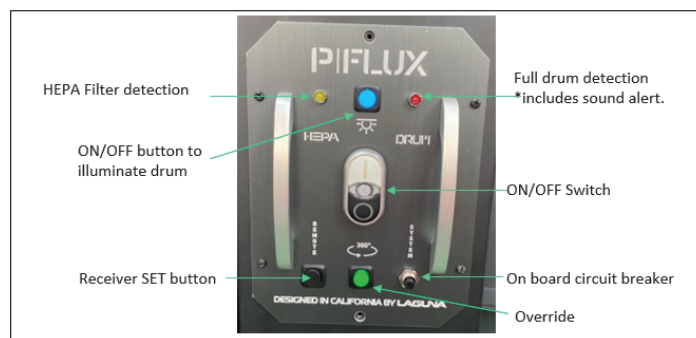

**HEPA Filter detection** – will illuminate when filter cleans (automatic cleaning/override)

**Full drum detection** – when drum is full, buzzer\* will constantly sound off and light will illuminate.

\*When the drum is close to 70%-80% full; intermittent buzzing will occur; this is a normal state.

**ON/OFF Switch** – turns cyclone **ON** or **OFF**.

**On board circuit breaker** – Pops out if machine overloads. Press to reset.

**Override** – Press for (3) seconds to activate override cleaning while the cyclone is ON. You can also activate this function by pressing the CLEAN button on the hand held remote for (3) seconds.

**Receiver SET button** – Used to program receiver.

**ON/OFF illuminate drum** – controls the LED light on the drum lid to illuminate inside the drum for visuals of the dust level.



\*Used to match up a new hand held control with the remote switch

### PROGRAMMING THE REMOTE CONTROL

1. Ensure the machine is switch ON before programming the remote control.
2. Press the black set button on the bottom of the remote switch until you hear two beeps.
3. Press the Remote set button on your hand held controller simultaneously with the black button until you hear **three beeps** to complete the set up.

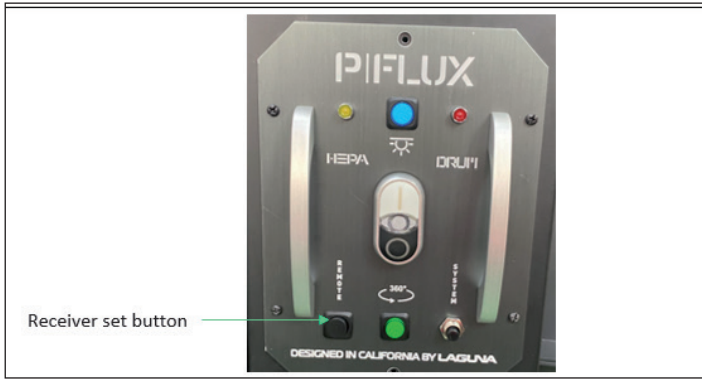

**MULTIPLE HAND HELD REMOTE SETUP**

You can pair up to five (MAX) hand held remotes; however each hand held remote needs to be setup individually following the programming steps above. If you setup a sixth hand held remote, it will override the first hand held remote. If a seventh hand held remote is setup, it will override the second hand held remote. And so on.

**5. Assembly**

**5.1 Unpacking**

Your 3HP Mobile Dust Cyclone comes packed in a single box. Before attempting to assemble this machine, follow these directions for unpacking:

1. Carefully cut the banding straps and remove them from the box.
2. Cut along the tape line at the top of the box.
3. Remove all parts from the top of the foam and set aside.
4. Remove the foam packing material from the top of the machine and set aside for further use, during assembly.
5. Cut the cardboard box (top to bottom) in the four corners for easy removal of the box.
6. Carefully take out the machine components from the box and set aside.
7. Using the diagram below, ensure that all parts are present and in good condition.

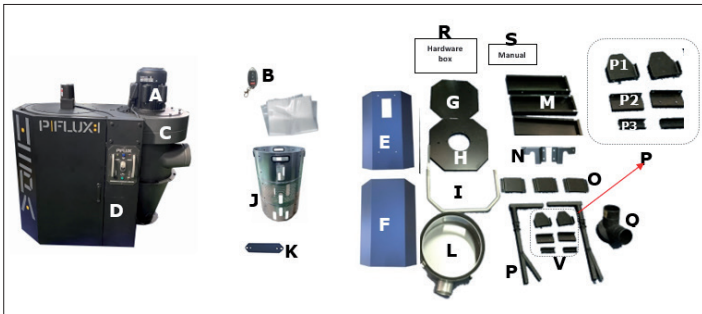

**Description**

- |                             |  |
|-----------------------------|--|
| A. Motor                    | M. Lower upright supports (3)              |
| B. Remote control           | N. Foot pedal bar (left and right)         |
| C. Dust chute               | O. Upright support reinforcement plate (3) |
| D. Top upright supports (3) | P. Foot pedal assembly fittings            |
| E. Octagon drum front panel | P1. Lower triangular support plate (2)     |
| F. Octagon drum back panel  | P2. Foot pedal bar support (2)             |
| G. Octagon drum base panel  | P3. Lower support plate (2)                |
| H. Octagon drum lid         | Q. Inlet adapter                           |
| I. Octagon drum foot pedal  | R. Hardware box (Casters, hardware)        |
| J. Drum insert              | S. Operating and Parts Manual              |
| K. Crossbar                 |  |
| L. End cap                  |  |

Report any missing or damaged parts to your dealer or distributor. Prior to tool assembly and use, read this manual thoroughly to familiarize yourself with proper assembly, maintenance and safety procedures.

**5.2 General Tool Assembly**

This step requires two adults. The 1.5 HP Mobile Dust Cyclone is heavy, be careful when lifting and handling it! Failure to comply may cause serious injury and/or damage to the machine and/or property!

**Tools Required**

- 10 mm wrench / 12 mm wrench / 14 mm wrench
- Phillips screwdriver. 4 mm hex wrench / 5 mm hex wrench

To assemble your dust cyclone, follow these steps: For your own safety, do not connect the machine to the power source until the machine is completely assembled. Please also make sure that you read and understand the entire instruction manual.

**ASSEMBLY TIME ESTIMATE 4-5 hours**

Step 1. Place the empty, top, foam packing insert (which contained the individual parts) upside-down on the floor. Place the main unit into the foam insert upside-down. Make sure the unit is centered properly and resting solidly in the foam insert for the next steps.



Step 2. Remove the base which has been bolted to the (3) top upright supports. Keep these bolts for step 4.

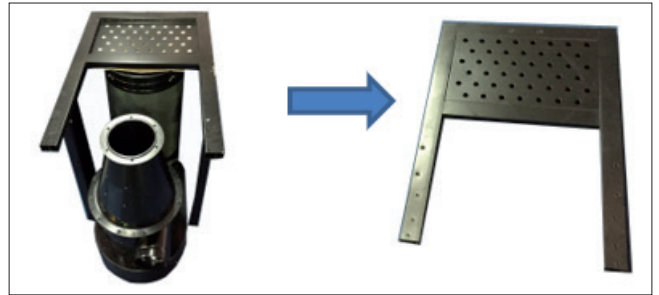

Step 3. Turn base upside-down. Use (16) 5/16" x 3/4" hex bolts and (16) 5/16" flat washers. Attach the (2) 4" casters with brakes to the base. The casters with brakes should be attached to the side with the opening. The remaining (2) 4" swivel casters must attach to the other end on the base.



Step 4. Turn the base over with it standing on the (4) 4" casters and secure the three lower upright support panels (tip of triangles need to face inwards) using (6) 3/8" x 3/4" hex bolts and (6) 3/8" x 7/8" flat washers. A – shown with one triangle is located on the canister side. B – shown with two triangles located on the front side C – shown with three triangles is located on the opposite end.

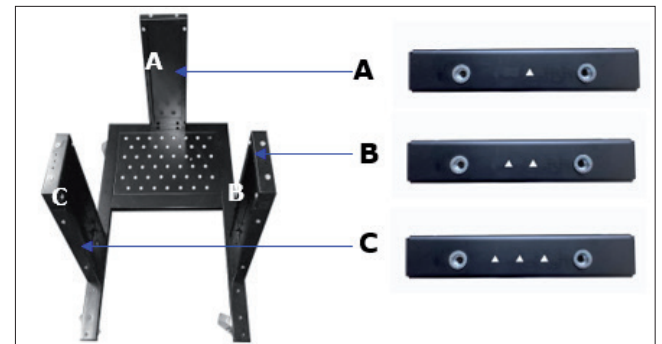

Step 5. Secure the base with (3) lower upright support panels to the unit using (6) 5/16" x 3/4" hex bolts and (6) 5/16" flat washers.



Step 6. Secure the (3) upright support reinforcement plates using (12) 5/16" x 3/4" hex bolts and (12) 5/16" flat washers.

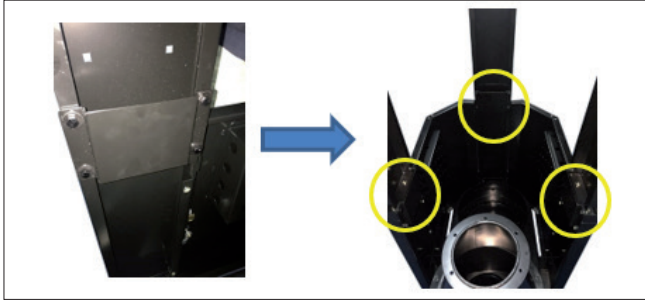

Step 7. With the help of another person, lift the unit up carefully and rotate to the right-side-up with the motor on top and the wheels at the bottom.

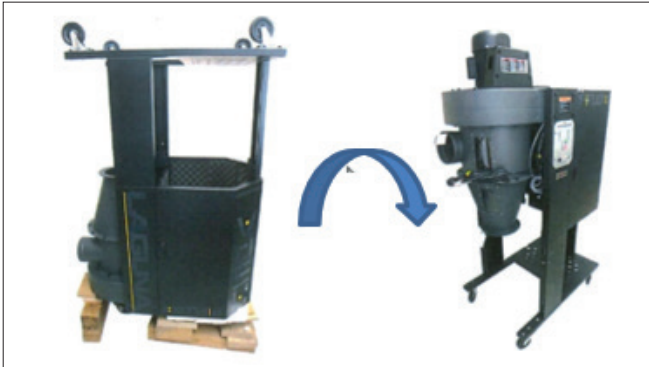

Step 8. Attach the canister filter end cap to the canister filter using the (4) latches. Cover the 4" hook up with the 4" plastic cap.



Step 9. Secure the lower triangular support plate to the base using (2) 5/16"x3/4" hex bolts and (2) 5/16"x18x2mm flat washers. Follow the same steps for the opposite side.

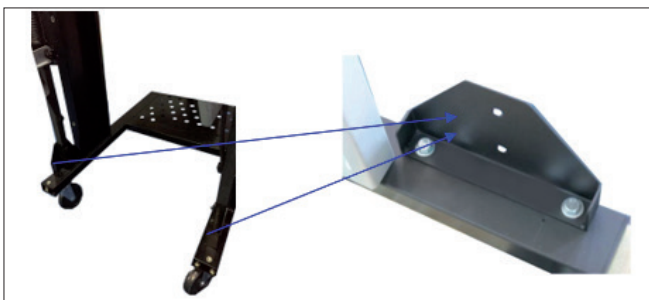

Step 10. Secure the foot pedal support bracket to the lower upright support panel using (2) 5/16"x1/2" carriage bolts, (2) 5/16"x18x2mm flat washers and (2) 5/16" hex nuts. Make sure the armrest of the support bracket is facing up. Follow the same steps for the opposite side.

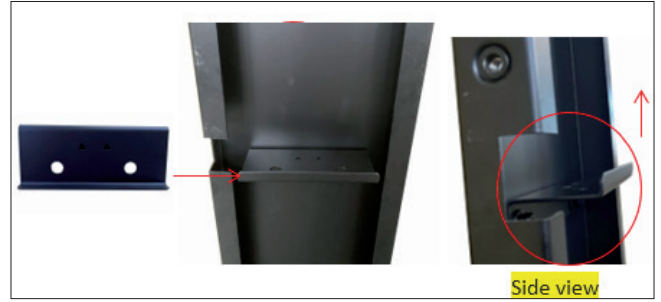

Step 11. Locate the two-foot pedal bars provided. There is a left side and right side. To identify the correct side, look for the protruding nut, circled in red below. It should be facing upwards when you place the bars on the floor.

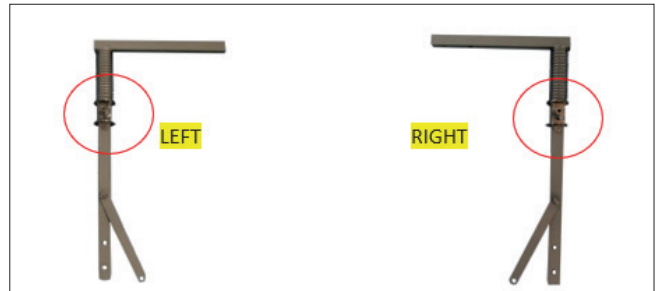

Step 12. Confirm the foot pedal bar is the correct side and slide the Foot pedal bar into the opening on the lower upright support panel. Make sure the end of the bar is on the inside of the triangular support plate. Follow the same steps for the opposite side.



Step 13. Secure the top end of the foot pedal bar to support bracket using (4) 5/16"x1-3/4" hex bolts, (8) 5/16"x18x2mm flat washers and (4) 5/16" hex nuts. Make sure the foot pedal bar is pushed all the way to the end of the support bracket (indicated by yellow arrows). Follow the same steps for the opposite side.

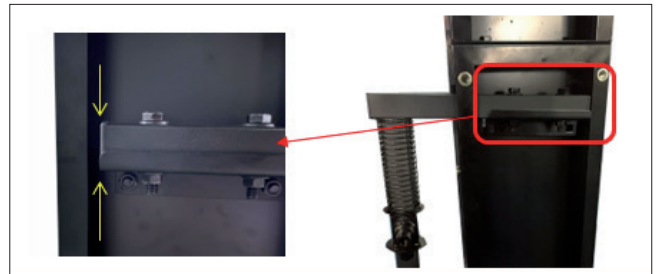

Step 14. Secure the base of the foot pedal bar to the triangular support plate by holding the lower support plate vertically up against the foot pedal bar and securing the U channel provided onto the foot pedal bar using (2) 5/16"x1-3/4" hex bolts, (4) 5/16"x18x2mm flat washers and (2) 5/16" hex nuts from the inside out. Follow the same steps for the opposite side.





Step 15. Attach the cover plate over the foot pedal assembly. Secure using (6) 1/4"x3/4" hex bolts and (6) 1/4" flat washers. Follow the same steps for the opposite side.



Step 16. Attach the two ends of the Octagon foot pedal to the nut on the foot pedal bar.

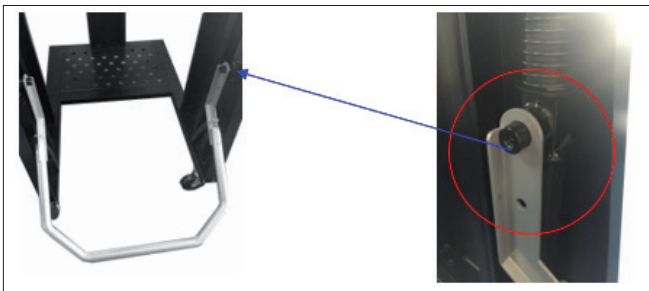

Step 17. Secure the topping to the nut on the foot pedal bar using (1) M8x30mm hex bolt. Follow this step on the opposite side.



Step 18. Secure the movable supporting brace on the foot pedal bar with the octagon foot peddle using (2) 3/8" hex bolts and ((2) 3/8" hex lock nuts. Make sure the bolt head is on the inside of the octagon foot pedal. Adjust the tightness of this bolt accordingly. If this bolt is too tight, the Octagon foot pedal will not work smoothly. When too loose it will not pick up the Octagon drum.

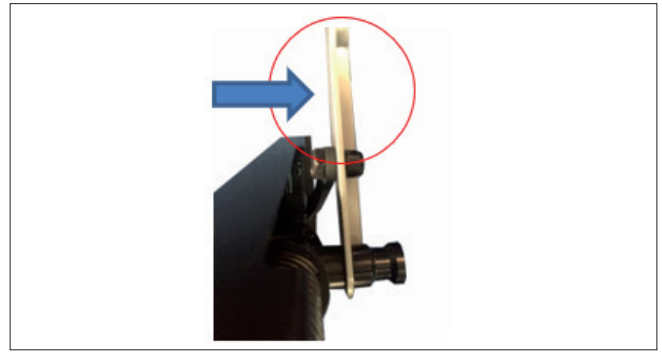
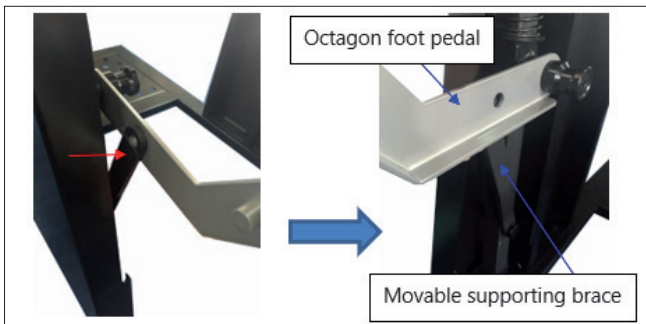

Step 19. Apply foam tape to the cone flange before attaching the drum lid. Secure the Octagon drum lid to the cyclone funnel first by using (4) 5/16" x 3/4" hex bolts, (8) 5/16" flat washers and (4) 5/16" hex nuts. Leave two bolt holes open for the next step. Make sure to first attach all the bolts before tightening. NOTE: The drum lid needs to be aligned with the drum for full seal. You can adjust the drum lid before the bolts have been tightened.



Step 20. Attach the full drum detection sensor to the opening on the drum lid located behind the cyclone funnel. When securing the sensor make sure the end of the sensor is shorter than the drum lid rim. If it extends longer passed the rim, sensor detection will not function correctly.

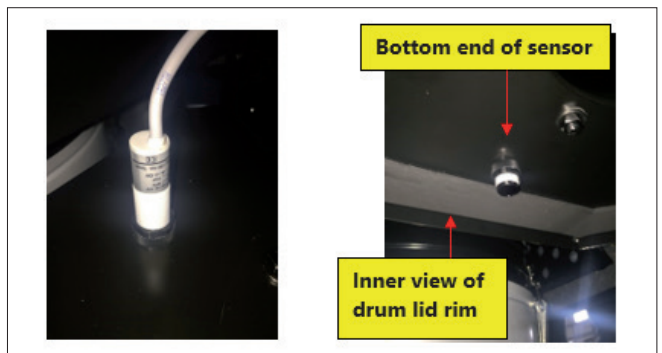

Step 21. Attach the LED light to the drum lid using (6) M4x10mm Philips Bolt, (6) 3/16" flat washers and (6) M4 hex nuts.

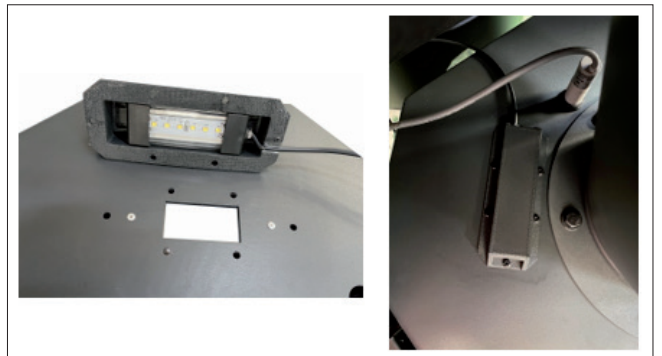

Step 22. Attach the crossbar to the drum lid and tighten using (2) 5/16" x 3/4" hex bolts, (4) 5/16" flat washers and (2) 5/16" hex nuts. It does not matter which position you attach the crossbar.



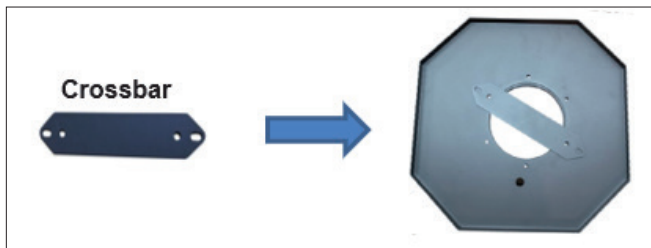

Step 23. Assemble the Octagon drum. Locate the drum base panel, (it does not matter which side faces inside), and secure the (4) 3" casters using (16) 5/16" x 3/4" hex bolts, (32) 5/16" flat washers and (16) 5/16" hex nuts.

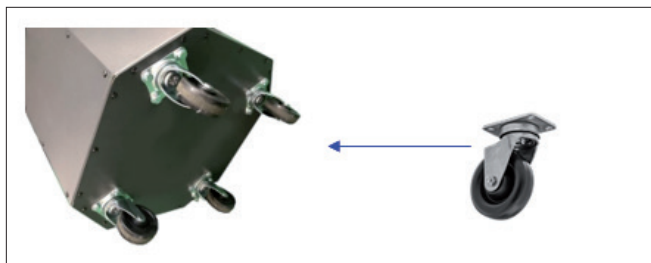

Step 24. Attach the handles to the top and bottom end on the front panel with the window display using (4) 5/16"x3/4" flat head Philip bolt, (4) 5/16" flat washers and (4) 5/16" hex nuts. Note that the head of the Philip bolt must be inserted from the handle with the hex nut and washer on the inside of the drum.



Step 25. Take the Octagon drum front and back panels and assemble by securing with (12) M4 x 12mm sheet metal screws.

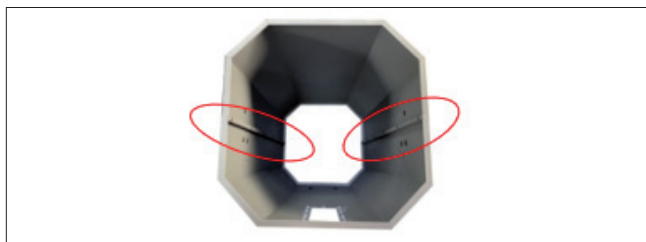

Step 26. One the left and right side you will find three bolt holes. Take the matching side plate and secure to the outside of the panel using (6) 1/4" x 1/2" carriage bolts, (6) 1/4" flat washers and (6) 1/4" hex nuts. Insert the head of the carriage bolt from the inside of the drum with the washers and nuts on the outside of the drum.

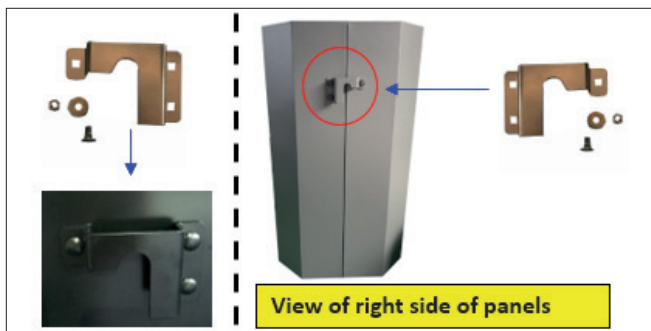

Step 27. Secure the Octagon base panel to the bottom of the drum using (22) M5 Sheet metal screws to secure tightly, make sure the head of the sheet metal screw is on the outside of the drum. Take the plastic bolt end

caps to cover all the bolt ends on the inside of the Octagon drum base. This step is necessary to prevent any injuries caused by the sharp end of the bolts.

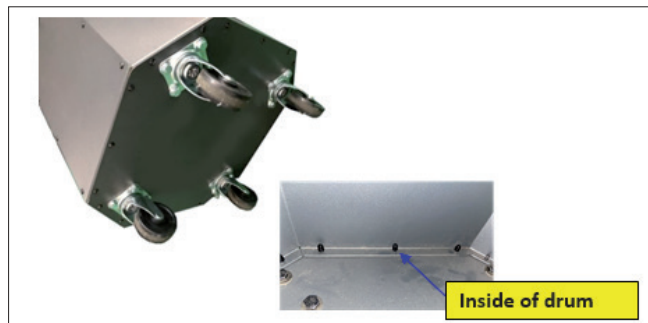

Step 28. Once completing the assembly, keep the drum laying on its side to apply silicone (not included) to the inside of the drum, including the base and the top rim of the drum before the rubber seal has been attached to seal and prevent air leakages. You will need to use a caulking gun (not supplied).

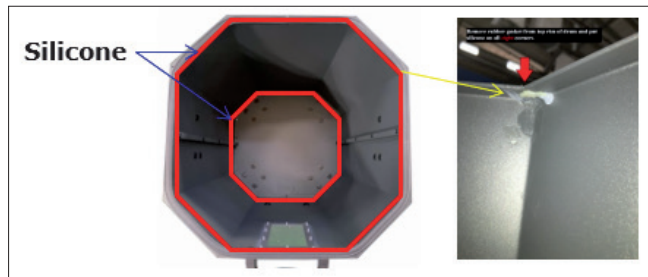

Step 29. Attach the rubber gasket to the top inner edges of the Octagon drum. The wider end of the gasket goes up. Use tin snips to trim any excess rubber gasket after completing the seal.

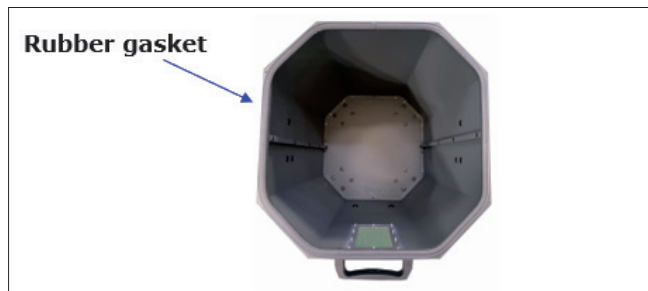

Step 30. Insert the plastic debris collection bag inside the Octagon drum. Open and spread out the plastic bag to the corners and edges.



Step 31. Use (24) Round head Philips bolts 3/16"x1/2" and (24) Cap nut 3/16" to assemble the drum insert together. Place the drum insert inside over the plastic bag in the Octagon drum.



Step 32. Lift the foot pedal bar. Align the Octagon drum window to the center point of the drum lid and push the drum in. Lower the foot pedal bar to seal the drum tight for normal machine operation.



Step 33. Make sure when aligning the drum that both the left and right-side lift plates are over the topping on the foot pedal bar assembly before lifting the foot peddle bar up. When not aligned, the drum will not be fully sealed and will interfere with the air flow.

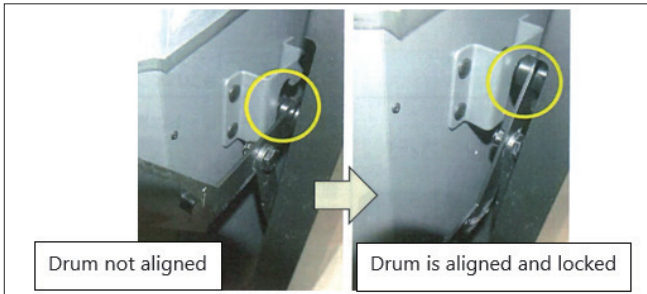

Step 34. Using the white plastic pin, insert the sharp point into the top end of the proximity sensor that is on top of the drum lid. You will find a small hole to on top where you can turn clockwise or counterclockwise.

- Clockwise: Lowers dust waste level in drum (Less full drum).
- Counterclockwise: Increases dust waste level in drum (Fuller drum).

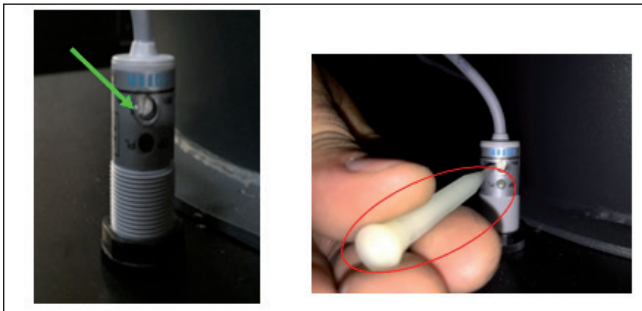

Step 35. Install the intake splitter 6" by 4" x 2 ports to the intake using (3) M4 x 12mm sheet metal screws. Attach the rubber caps to each 4" port.



Step 36. All the assembly steps have been completed.



## OPERATION

1. Make sure at least one blast gate is open, if connected to a dust collection system with blast gates.

**CAUTION** Never operate dust collector with all blast gates closed!

2. Confirm the electrical supply is correct and connected to machine.
3. Make sure no one is working on or doing maintenance to dust collector.
4. To start, press the ON button on either the ON/OFF switch or remote control.
5. To stop, press the OFF button on either the ON/OFF switch or remote control.

## 6. Maintenance procedures

### CLEANING THE FILTER

This PFLUX1 is equipped with auto clean every 10 minutes for 10 seconds one direction and another 10 seconds the other direction. The cleaning will continue for one cycle (10 seconds clockwise, 10 seconds counterclockwise when you shut the machine off. While the canister is cleaning the yellow LED light on the control panel will illuminate showing that it is in the process of cleaning.

There is a HEPA filter replacement indicator, which is the same yellow LED light as the cleaning one. This is based on a timer system and when 2000 hours of running is reached, the light indication would be flash constantly in one long, two short intervals meaning the HEPA filter would need to be replaced.

Pressing the REMOTE button five times will reset the flashing light.

To ensure proper operation of this Mobile Dust Cyclone, the HEPA canister filter must have adequate air flow. This means the filter must be regularly maintained by carefully blowing the filter clean using compressed air and an air gun to release built-up particulates trapped between the filter pleats.

**CAUTION DISCONNECT MACHINE FROM POWER!**

For heavy duty users, it is recommended to use compressed air on a weekly basis to maintain maximum filtration efficiency and longer life span of the filter.

1. Keep your cyclone switched on and operating; open both sides of the Canister filter shield doors. Connect the Ø4" flex hose from the cyclone to the Ø4" hook up on the canister end cap.



2. While the cyclone is collecting the dust from inside the canister end cap; use compressed air and an air gun and blow the outer surface of the canister.

3. After cleaning the filter with the compressed air gun, follow the steps in the next section to remove the end cap to empty out any dust left inside.

### EMPTYING THE CANISTER END CAP

Periodically check the canister end cap, if it is more than one third full, it is recommended that you empty it.

**NOTE:** If the canister end cap gets too full, the dust particulates may be recirculated back into the canister filter obstructing air flow and exposing the user to potentially harmful particulates.

1. Release the (4) latches around the canister end cap to remove.
2. Empty and re-attach using the latches.

### EMPTYING THE DRUM

Periodically inspect the contents of the drum and empty as needed. To inspect the contents of the drum:

1. Raise the drum foot peddle bar to lower the drum to the floor.
2. Roll it away from the machine, inspect and empty as needed.

## ROUTINE INSPECTION

It is a good idea to routinely inspect any quality woodworking tool in order to keep it in optimum condition. This includes inspecting all hardware for tightness, ensuring the filter is clean, and cleaning debris and grime from any surfaces and moving parts.

## HEPA FILTER REPLACEMENT

To maintain safe, clean air quality, the HEPA filter should be replaced after 2000 hours of operation (e.g., 8 hours/day x 250 days = 2,000 hours). Contact your dealer or Laguna Tools for a replacement HEPA filter. If your model has a "change filter indicator light" it will flash at 2,000 hours. Replace HEPA filter. To reset flashing light, press the "Remote" button on the Control Panel 5 times.

**CAUTION DISCONNECT MACHINE FROM POWER!**

## REMOVING THE CANISTER FILTER

1. Release the spring-loaded band clamp at the bottom of the canister filter and remove the plastic bag.



2. While supporting the canister filter assembly from the bottom, release the spring-loaded band clamp from the top of the canister filter assembly.



3. Remove the (4) 3/16" x 3/4" sheet metal Philip bolts, (1) 5/16" x 3/4" hex bolt and (1) 5/16" x 7/8" flat washer off the bottom of the canister filter.

4. Remove the canister filter and carefully tilt the top of the canister filter assembly to clear the paddle branches. Slightly bend the paddle branches to remove the canister filter.

**NOTE:** You may have to gently bend the paddles to free the canister filter. This should not adversely affect the operation of the machine.

5. With the canister filter removed use a compressed air gun to thoroughly clean between the pleats, both inside and outside.

## RE-ASSEMBLING THE CANISTER FILTER AFTER CLEANING

6. With the aid of another person, carefully re-insert the canister filter repeating step 1,2,3 and 4 in reverse.



## 7. Troubleshooting guide

<p><b>Machine does not start or a breaker trips.</b></p> <p>Possible Cause</p> <ol style="list-style-type: none"> <li>1. Power supply switched OFF or is faulty.</li> <li>2. Wall fuse/circuit breaker is blown/tripped.</li> <li>3. Faulty remote control.</li> <li>4. Remote receiver is faulty.</li> <li>5. Incorrectly wired motor connection.</li> <li>6. On-board circuit breaker is tripped.</li> <li>7. Wiring is open/has high resistance.</li> <li>8. Faulty power switch.</li> <li>9. Motor is at fault.</li> </ol>	<p>Possible Solution</p> <ol style="list-style-type: none"> <li>1. Ensure power supply is ON and has the correct voltage.</li> <li>2. Ensure adequate circuit size; install inlet restrictor, replace weak breaker.</li> <li>3. Replace batteries; ensure unobstructed line-of-sight and signal range.</li> <li>4. Inspect receiver circuit board; replace if faulty.</li> <li>5. Rewire or call certified service technician or electrician.</li> <li>6. Allow motor to cool, improve ventilation, press reset button.</li> <li>7. Check for broken wires or poor connections, repair as necessary.</li> <li>8. Replace switch.</li> <li>9. Test/repair/replace.</li> </ol>
<p><b>Excessive vibration or noise during operation.</b></p> <p>Possible Cause</p> <ol style="list-style-type: none"> <li>1. Loose component.</li> <li>2. Loose or broken motor mount.</li> <li>3. Motor fan hitting fan cover.</li> <li>4. Bad motor bearings.</li> </ol>	<p>Possible Solution</p> <ol style="list-style-type: none"> <li>1. Inspect and tighten all bolts/nuts.</li> <li>2. Tighten or replace as needed.</li> <li>3. Check fan and cover; replace as needed.</li> <li>4. Rotate shaft manually, check for grinding or loose shaft, replace bearings if needed.</li> </ol>
<p><b>Loud, repetitive noise, or excessive vibration coming from cyclone</b></p> <p>Possible Cause</p> <ol style="list-style-type: none"> <li>1. Machine is on uneven surface.</li> <li>2. Damaged/Unbalanced impeller.</li> <li>3. Loose connections.</li> <li>4. Impeller is loose.</li> <li>5. Motor fan hitting fan cover.</li> </ol>	<p>Possible Solution</p> <ol style="list-style-type: none"> <li>1. Stabilize on a flat surface.</li> <li>2. Inspect impeller for dents, bends, loose fins. Replace if needed.</li> <li>3. Check and re-tighten all fasteners.</li> <li>4. Replace the motor and impeller.</li> <li>5. Check fan and cover; replace as needed.</li> </ol>
<p><b>Dust cyclone does not adequately collect dust or chips; poor performance.</b></p> <p>Possible Cause</p> <ol style="list-style-type: none"> <li>1. Canister end cap is full.</li> <li>2. Filter is dirty.</li> <li>3. Restricted duct line.</li> <li>4. Suction route is too long or has too many sharp bends.</li> <li>5. Wet lumber is clogging ducts.</li> <li>6. Leaks in the duct work or too many open ports.</li> <li>7. Inadequate velocity in the main suction line.</li> <li>8. Wrong size ducting/ports used.</li> </ol>	<p>Possible Solution</p> <ol style="list-style-type: none"> <li>1. Empty canister end cap.</li> <li>2. Clean filter.</li> <li>3. Clean inlet splitter.</li> <li>4. Move machine closer to the point of suction, and rerun ducts to eliminate sharp bends.</li> <li>5. Use lumber with less than 20% moisture content.</li> <li>6. Repair all duct leaks and close any ports not being used.</li> <li>7. Increase velocity by opening 1 or 2 more blast gates to different branch lines.</li> <li>8. Re-size and re-install ducts and fittings.</li> </ol>
<p><b>Sawdust being blown into the air from the dust cyclone.</b></p> <p>Possible Cause</p> <ol style="list-style-type: none"> <li>1. Band clamp or end cap is not secure.</li> <li>2. Loose or damaged seals.</li> </ol>	<p>Possible Solution</p> <ol style="list-style-type: none"> <li>1. Re-install ensuring a tight fit.</li> <li>2. Replace seals and gaskets.</li> </ol>

## 8. POWER CONNECTIONS & WIRING DIAGRAMS

### POWER CONNECTIONS

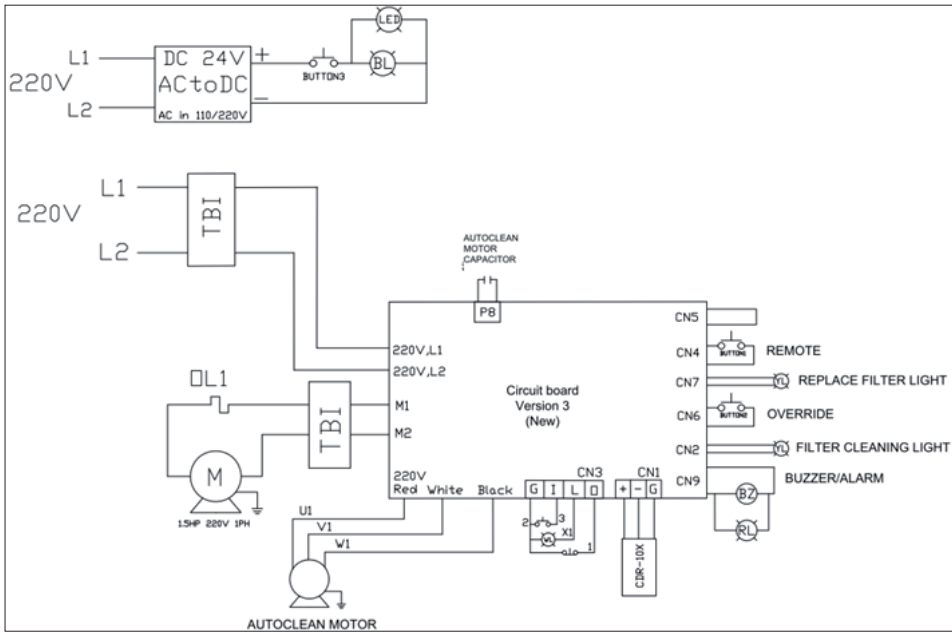

### AUTOCLEAN MOTOR

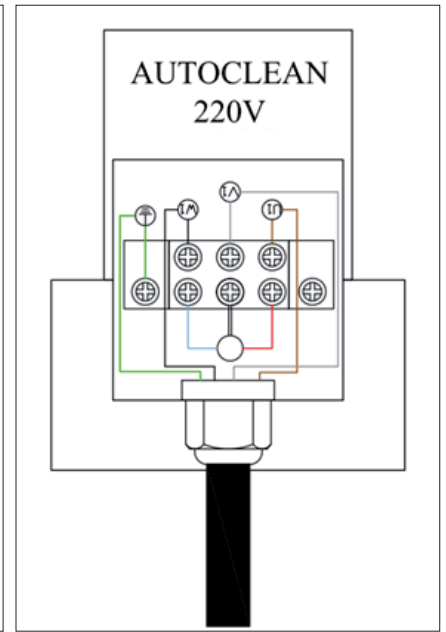

### CONTROL PANEL

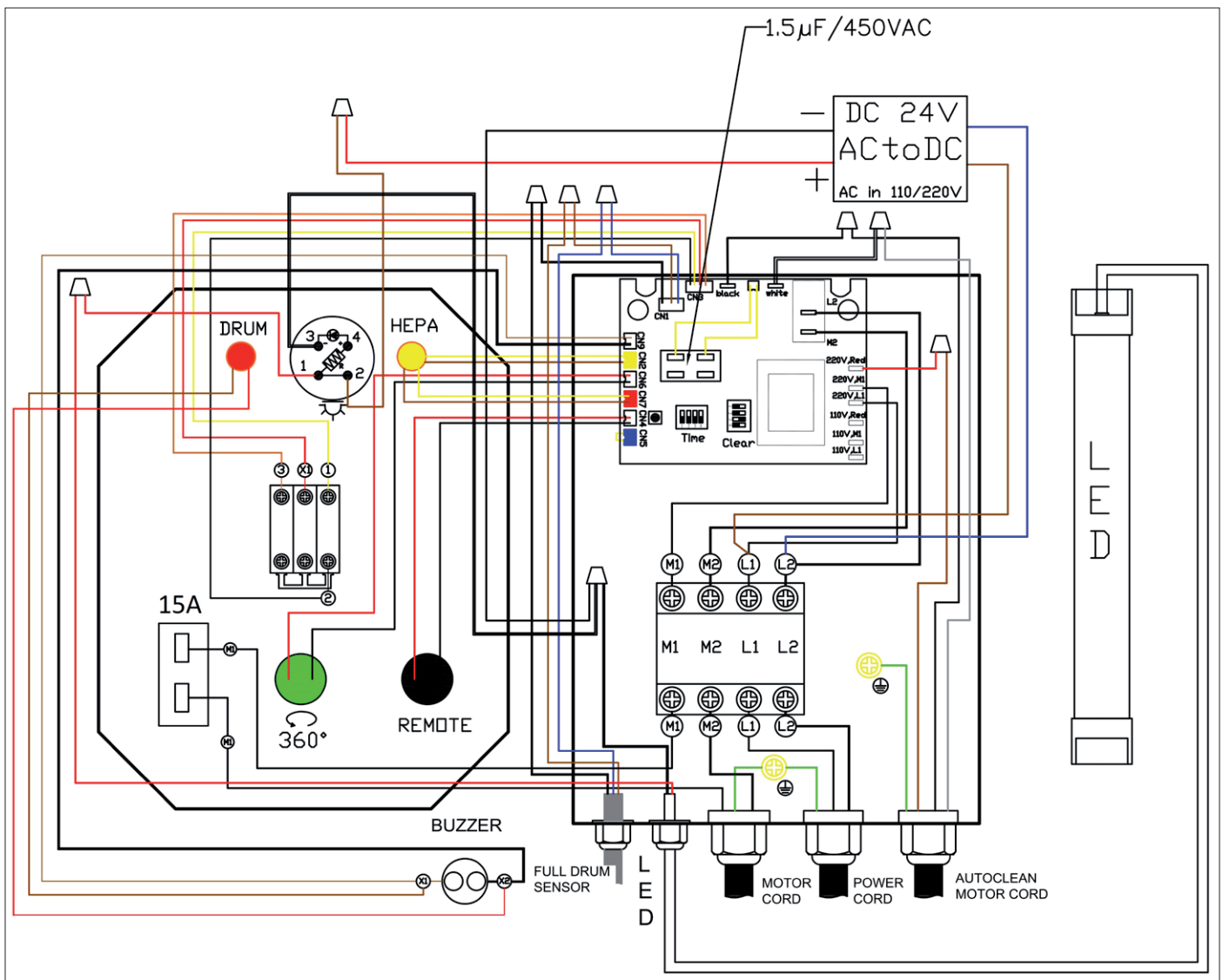

## 9. Parts breakdown / Exploded Views

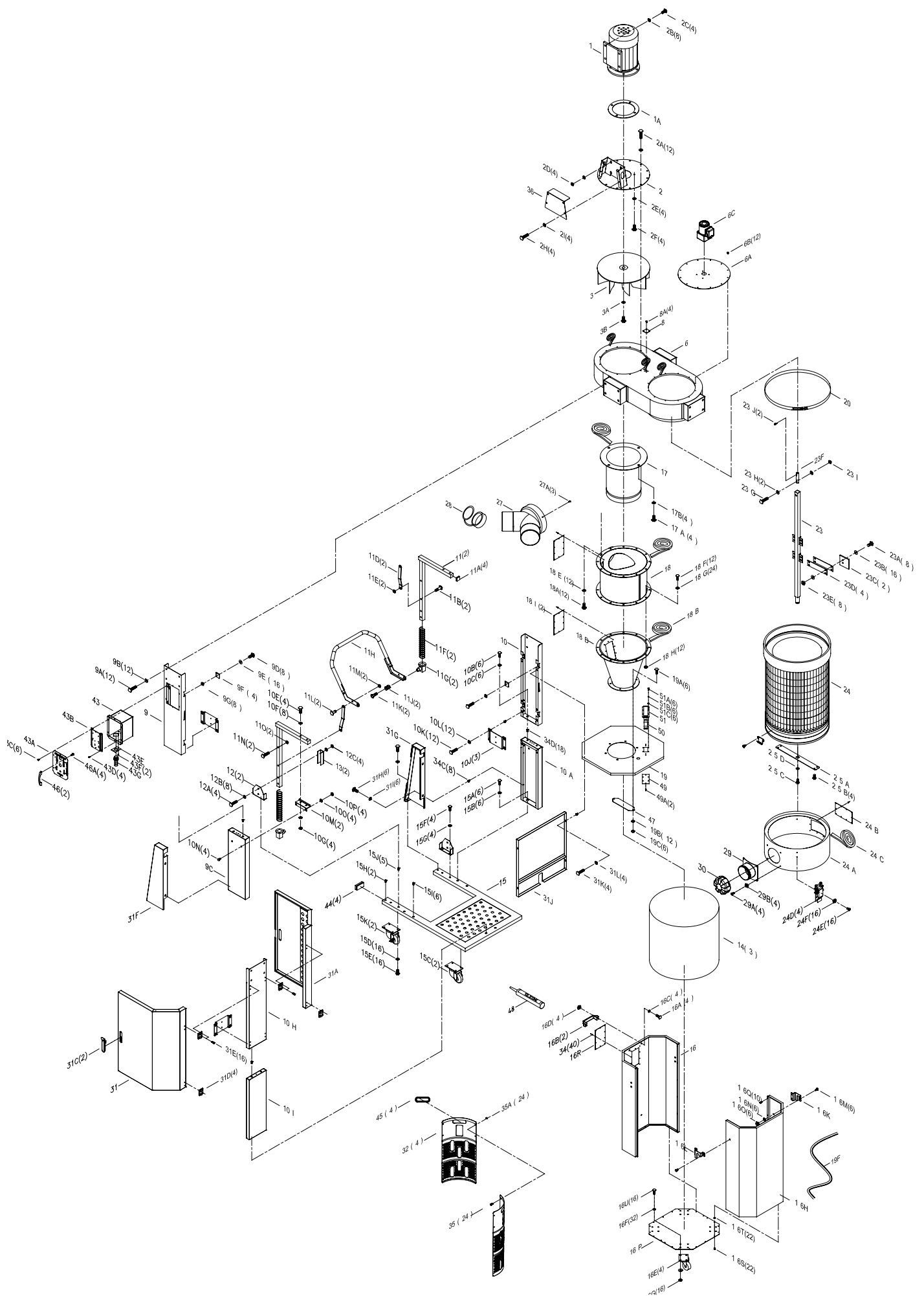



## 10. Parts list

Ref No	Part Number	Part Name & Description	QTY
1	PDCPF15110-1	MOTOR 1.5HP	1
1A	PDCPF15110-1A	MOTOR GASKET	1
2	PDCPF15110-2	MOTOR SUPPORT BASE	1
2A	PDCPF15110-2A	HEX LOCK BOLT 5/16" x 5/8"	12
2B	PDCPF15110-2B	FLAT WASHER 3/8"x23x2mm	8
2C	PDCPF15110-2C	HEX BOLT 3/8" x 1"	4
2D	PDCPF15110-2D	HEX NUT 3/8"	4
2E	PDCPF15110-2E	FLAT WASHER 5/16"x18x2mm	4
2F	PDCPF15110-2F	HEX BOLT 5/16" x 3/4"	4
2H	PDCPF15110-2H	HEX BOLT 1/4" x 3/4"	4
2I	PDCPF15110-2I	FLAT WASHER 1/4"x19x1mm	4
3	PDCPF15110-3	FAN 340mm	1
3A	PDCPF15110-3A	FLAT WASHER 5/16"x30x3mm	1
3B	PDCPF15110-3B	HEX BOLT 5/16"x3/4"	1
6	PDCPF15110-6	DUST CHUTE	1
6A	PDCPF15110-6A	CANISTER COVER PLATE	1
6B	PDCPF15110-6B	SHEET METAL THREAD BOLT 3/16" x 1/2"	12
6C	PDCPF15110-6C	AUTO CLEAN MOTOR	1
8	PDCPF15110-8	COVER PLATE	1
8A	PDCPF15110-8A	SHEET METAL THREAD BOLT M4x12mm	4
9	PDCPF15110-9V2	TOP UPRIGHT SUPPORT B V2.2021	1
9A	PDCPF15110-9A	HEX BOLT 5/16" x 3/4"	12
9B	PDCPF15110-9B	FLAT WASHER 5/16"x18x2mm	12
9C	PDCPF15110-9C	LOWER UPRIGHT SUPPORT TWO DOT (3B)	1
9D	PDCPF15110-9D	HEX BOLT 1/4"x5/8"	8
9E	PDCPF15110-9E	FLAT WASHER 1/4"x13x1mm	16
9F	PDCPF15110-9F	DOOR STOP PLATE	4
9G	PDCPF15110-9G	HEX NUT 1/4"	8
10	PDCPF15110-10V2	TOP UPRIGHT SUPPORT A V2.2021	1
10A	PDCPF15110-10A	LOWER UPRIGHT SUPPORT THREE DOT	1
10B	PDCPF15110-10B	HEX BOLT 5/16" x 3/4"	6
10C	PDCPF15110-10C	FLAT WASHER 5/16"x18x2mm	6
10E	PDCPF15110-10E	HEX BOLT 5/16" x 1-3/4"	4
10F	PDCPF15110-10F	FLAT WASHER 5/16"x18x2mm	8
10G	PDCPF15110-10G	HEX NUT 5/16"	4
10H	PDCPF15110-10H	TOP UPRIGHT SUPPORT ONE DOT (1A)	1
10I	PDCPF15110-10I	LOWER UPRIGHT SUPPORT ONE DOT	1
10J	PDCPF15110-10J	UPRIGHT SUPPORT REINFORCEMENT PLATE	3
10K	PDCPF15110-10K	HEX BOLT 5/16" x 3/4"	12
10L	PDCPF15110-10L	FLAT WASHER 5/16"x18x2mm	12
10M	PDCPF15110-10M	FOOT PEDAL BAR SUPPORT	2
10N	PDCPF15110-10N	CARRIAGE BOLT 5/16"x1/2"	4
10O	PDCPF15110-10O	FLAT WASHER 5/16"x18x2mm	4
10P	PDCPF15110-10P	HEX NUT 5/16"	4
11	PDCPF15110-11	FOOT PEDAL BAR	2
11A	PDCPF15110-11A	PLUG 25, 25	4
11B	PDCPF15110-11B	HEX BOLT 3/8"	2
11D	PDCPF15110-11D	MOVEABLE SUPPORT BRACE	2
11E	PDCPF15110-11E	HEX LOCK NUT 3/8"	2
11F	PDCPF15110-11F	SPRING 42mm x 242mm	2
11G	PDCPF15110-11G	SKID BLOCK	2
11H	PDCPF15110-11H	OCTAGON DRUM FOOT PEDAL	1
11J	PDCPF15110-11J	TOPPING 24x30mm	1
11K	PDCPF15110-11K	HEX BOLT M8x30mm	2
11L	PDCPF15110-11L	HEX BOLT 3/8"	2
11M	PDCPF15110-11M	HEX LOCK NUT 3/8"	2
11N	PDCPF15110-11N	HEX BOLT 3/8" x 1-1/2"	2
11O	PDCPF15110-11O	HEX LOCK NUT 3/8"	2
12	PDCPF15110-12	TRIANGULAR SUPPORT PLATE	2
12A	PDCPF15110-12A	HEX BOLT 5/16" x 1-3/4"	4
12B	PDCPF15110-12B	FLAT WASHER 5/16"x18x2mm	8
12C	PDCPF15110-12C	HEX NUT 5/16"	4
13	PDCPF15110-13	LOWER SUPPORT PLATE	2
14	PDCPF15110-14V2	PLASTIC BAG 610 x 1200mm	3
15	PDCPF15110-15	BASE	1
15A	PDCPF15110-15A	HEX BOLT 3/8" x 3/4"	6
15B	PDCPF15110-15B	FLAT WASHER 3/8" x 23 x 2mm	6
15C	PDCPF15110-15C	SWIVEL CASTER 4"	2
15D	PDCPF15110-15D	FLAT WASHER 5/16"x18x2mm	16
15E	PDCPF15110-15E	HEX BOLT 5/16" x 3/4"	16
15F	PDCPF15110-15F	HEX BOLT 5/16" x 3/4"	4
15G	PDCPF15110-15G	FLAT WASHER 5/16"x18x2mm	4
15H	PDCPF15110-15H	RIVET NUT 1/4"	4
15I	PDCPF15110-15I	RIVET NUT 3/8"	6
15J	PDCPF15110-15J	RIVET NUT 5/16"	5
15K	PDCPF15110-15K	SWIVEL CASTER W/BRAKES 4"	2
16	PDCPF15110-16V2	OCTAGON DRUM FRONT PANEL V2.2021	1
16A	PDCPF15110-16A	FLAT HEAD PHILIPS BOLT 5/16"x3/4"	4
16B	PDCPF15110-16B	HANDLE	2
16C	PDCPF15110-16C	FLAT WASHER 5/16"x23x2mm	4
16D	PDCPF15110-16D	HEX NUT 5/16"	4
16E	PDCPF15110-16E	DRUM CASTER 3"	4
16U	PDCPF15110-16U	HEX BOLT 5/16" x 3/4"	4
16F	PDCPF15110-16F	FLAT WASHER 5/16"x18x2mm	32
16G	PDCPF15110-16G	HEX NUT 5/16"	16
16H	PDCPF15110-16HV2	OCTAGON DRUM BACK PANEL V2.2021	1

Ref No	Part Number	Part Name & Description	QTY
16K	PDCPF15110-16K	LEFT SIDE PLATE	1
16L	PDCPF15110-16L	RIGHT SIDE PLATE	1
16M	PDCPF15110-16M	CARRIAGE BOLT 1/4" x 1/2"	6
16N	PDCPF15110-16N	FLAT WASHER 1/4"x19x2mm	6
16O	PDCPF15110-16O	HEX NUT 1/4"	6
16P	PDCPF15110-16PV2	OCTAGON DRUM BASE PANEL V2.2021	1
16R	PDCPF15110-16RV2	WINDOW V2.2021	1
16S	PDCPF15110-16SV2	M5 SHEET METAL BOLTS	22
16T	PDCPF15110-16TV2	PLASTIC BOLT END CAP	22
16Q	PDCPF15110-16Q	THREAD BOLT M4 x 12mm	12
17	PDCPF15110-17	INTAKE CYLINDER	1
17A	PDCPF15110-17A	HEX BOLT 5/16" x 5/8"	4
17B	PDCPF15110-17B	FLAT WASHER 5/16"x18x2mm	4
18	PDCPF15110-18	CYCLONE BARREL	1
18A	PDCPF15110-18A	HEX BOLT 5/16" x 3/4"	12
18B	PDCPF15110-18B	FOAM TAPE 3 x 6mm x 1M	1
18D	PDCPF15110-18DV2	CYCLONE FUNNEL V2.2021	1
18E	PDCPF15110-18E	FLAT WASHER 5/16"x18x2mm	12
18F	PDCPF15110-18F	HEX BOLT 5/16" x 3/4"	12
18G	PDCPF15110-18G	FLAT WASHER 5/16"x18x2mm	24
18H	PDCPF15110-18H	HEX NUT 5/16"	12
18I	PDCPF15110-18I	WINDOW	2
19	PDCPF15110-19V2	OCTAGON DRUM LID V2.2021	1
19A	PDCPF15110-19A	HEX BOLT 5/16" x 3/4"	6
19B	PDCPF15110-19B	FLAT WASHER 5/16"x18x2mm	12
19C	PDCPF15110-19C	HEX NUT 5/16"	6
19F	PDCPF15110-19F	RUBBER GASKET 1400mm	1
20	PDCPF15110-20	BAND CLAMP 400mm	1
23	PDCPF15110-23V2	ROTATION SHAFT V2.2021	1
23A	PDCPF15110-23A	HEX BOLT 1/4" x 5/8"	8
23B	PDCPF15110-23B	FLAT WASHER 1/4" x 13 x 1mm	16
23C	PDCPF15110-23C	PADDLE	2
23D	PDCPF15110-23D	PADDLE BRANCH	4
23E	PDCPF15110-23E	HEX LOCK NUT 1/4"	8
23F	PDCPF15110-23F	ROTATION SHAFT CONNECTION	1
23G	PDCPF15110-23G	HEX BOLT 5/16" x 1-1/2"	1
23H	PDCPF15110-23H	FLAT WASHER 5/16"x18x2mm	2
23I	PDCPF15110-23I	HEX LOCK NUT 5/16"	1
24	PDCPF15110-24	HEPA FILTER 400 x 500mm	1
24A	PDCPF15110-24A	HEPA END CAP	1
24B	PDCPF15110-24B	WINDOW	1
24C	PDCPF15110-24C	FOAM TAPE 5x20mmx1.3M	1
24D	PDCPF15110-24D	LATCH #98	4
24E	PDCPF15110-24E	SHEET METAL BOLT 3/16"x3/8"	16
24F	PDCPF15110-24F	HEX NUT 3/16"	16
25A	PDCPF15110-25A	ROTATION SHAFT BASE	1
25B	PDCPF15110-25B	SHEET METAL PHILIP BOLT 3/16" x 3/4"	4
25C	PDCPF15110-25C	HEX BOLT 5/16" x 3/4"	1
25D	PDCPF15110-25D	FLAT WASHER 5/16" x 23 x 2mm	1
27	PDCPF15110-27	INTAKE SPLITTER 6" x 4" x 2	1
27A	PDCPF15110-27A	SHEET METAL BOLT M4 x 12mm	3
28	PDCPF15110-28	RUBBER CAP 4" FOR INTAKE	1
29	PDCPF15110-29	PLASTIC BASE CONNETTOR	1
29A	PDCPF15110-29A	PH HD BOLT 3/16" x 3/8"	4
29B	PDCPF15110-29B	HEX NUT 3/16"	4
30	PDCPF15110-30	PLASTIC CAP 4" FOR END CAP	1
31	PDCPF15110-31	CANISTER FILTER SHIELD DOOR-1	1
31A	PDCPF15110-31A	CANISTER FILTER SHIELD DOOR-2	1
31C	PDCPF15110-31C	DOOR HANDLE	2
31D	PDCPF15110-31D	HINGE	4
31E	PDCPF15110-31E	HEX BOLT M5x10mm	16
31F	PDCPF15110-31F	COVER PLATE RIGHT	1
31G	PDCPF15110-31G	COVER PLATE LEFT	1
31H	PDCPF15110-31H	HEX BOLT 1/4"x3/4"	6
31I	PDCPF15110-31I	FLAT WASHER 1/4"x19x1mm	6
31J	PDCPF15110-31J	CANISTER FILTER SHIELD	1
31K	PDCPF15110-31K	HEX BOLT 1/4"x3/4"	4
31L	PDCPF15110-31L	FLAT WASHER 1/4"x19x1mm	4
32	PDCPF15110-32	DRUM INSERT	4
34	PDCPF15110-34	RIVET	40
34C	PDCPF15110-34C	RIVET NUT 1/4"	8
34D	PDCPF15110-34D	RIVET NUT 5/16"	18
35	PDCPF15110-35	SHEET METAL BOLT 3/16"x1/2"	24
35A	PDCPF15110-35A	NUT 3/16"	24
36	PDCPF15110-36	MOTOR SWITCH SUPPORT BASE COVER PLATE	1
43	PDCPF15110-43V2	CONTROL BOX V2.2021	1
43A	PDCPF15110-43AV2	CONTROL PANEL V2.2021	1
43B	PDCPF15110-43BV2	CONTROL PANEL SUPPORT PLATE V2.2021	1
43C	PDCPF15110-43C	ROUND HEAD BOLT M4x10mm	6
43D	PDCPF15110-43D	PHILIP HD BOLT M4x6mm	4
43E	PDCPF15110-43E	BUZZER SUPPORT PLATE	1
43F	PDCPF15110-43F	PHILIP HD BOLT M4x6mm	1
43G	PDCPF15110-43G	BUZZER/ALARM	2
44	PDCPF15110-44	PLUG 30x60mm	4
45	PDCPF15110-45	RUBBER HANDLE FOR DRUM INSERT	4
46	PDCPF15110-46	CONTROL PANDLE HANDLE	2

Ref No	Part Number	Part Name & Description	QTY
46A	PDCPF15110-46A	PHILIP HD BOLT M4x6mm	4
47	PDCPF15110-47	CROSSBAR	1
48	PDCPF15110-48	SILICONE (not included)	1
49	PDCPF15110-49	LED WINDOW	1
49A	PDCPF15110-49A	RIVET 3-2	2
50	PDCPF15110-50	LED LIGHT	1
51	PDCPF15110-51	LED LIGHT COVER	1
51A	PDCPF15110-51A	PHILIP HD BOLT M4x10mm	6
51B	PDCPF15110-51B	FLAT WASHER 3/16"x12x1mm	6
51C	PDCPF15110-51C	HEX NUT M4	6
52	PDCCFPF-ICV3	Circuit Board (Gen 2,V3) (not shown)	1



IGM nástroje a stroje s.r.o., Ke Kopanině 560,  
Tuchoměřice, 252 67, Czech Republic, E.U.  
+420 220 950 910, [www.igm.cz](http://www.igm.cz)